

SPICE thermal model

BUK7Y7R8-80E

Symbol	Parameter	Conditions	Min	Typ	Max	Unit
$R_{th(j-mb)}$	thermal resistance from junction to mounting base		-	-	0.63	K/W

C_{th1}	7.578E-05 F
C_{th2}	5.163E-04 F
C_{th3}	5.303E-04 F
C_{th4}	4.594E-03 F
C_{th5}	8.156E-03 F
C_{th6}	1.766E-02 F
C_{th7}	2.995E-01 F
R_{th1}	1.090E-03 Ω
R_{th2}	1.835E-03 Ω
R_{th3}	1.563E-02 Ω
R_{th4}	2.408E-02 Ω
R_{th5}	1.003E-01 Ω
R_{th6}	4.443E-01 Ω
R_{th7}	4.209E-02 Ω

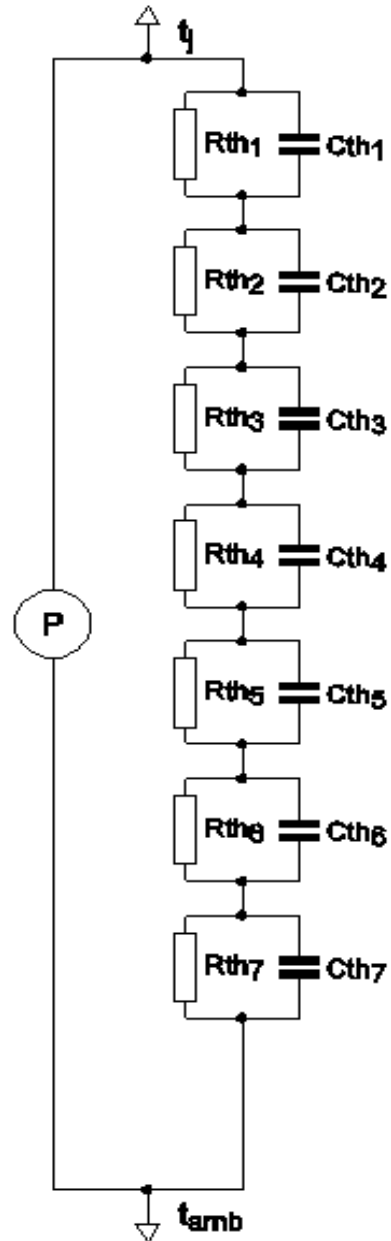

Part: BUK7Y7R8-80E
 Date: 25/1/2013
 Rth 0.63 K/W